

# bios

## Icarus<sup>®</sup> Ti2

SPECTRALLY OPTIMIZED  
EASY-TO-INSTALL  
Energy Efficient

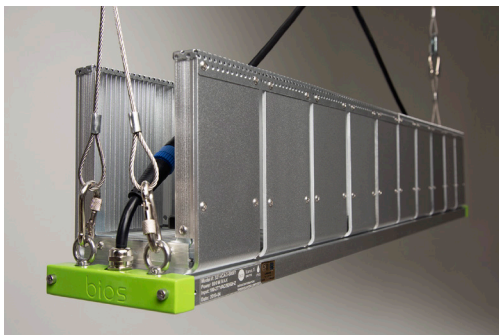

## Greenhouse - Top Light Applications

### Exceptional PAR Output and PAR Efficacy

BIOS Icarus Ti2 LED grow lights offer maximum light output in a minimal footprint and durable form factor to boost crop production for greenhouse or indoor top light growing environments.

### Features and Benefits

- + Fully assembled, industrial grade construction and durability.
- + Optimized broad spectrum, dimmable light for all phases of plant growth and production.
- + Remote 608W power supply (LED driver) for ease of installation.
- + Unique heat pipe thermal design allows for passive cooling, eliminating fans, moving parts, and noise.

### Scientifically Engineered Spectrum Maximizes Photosynthesis and Growth

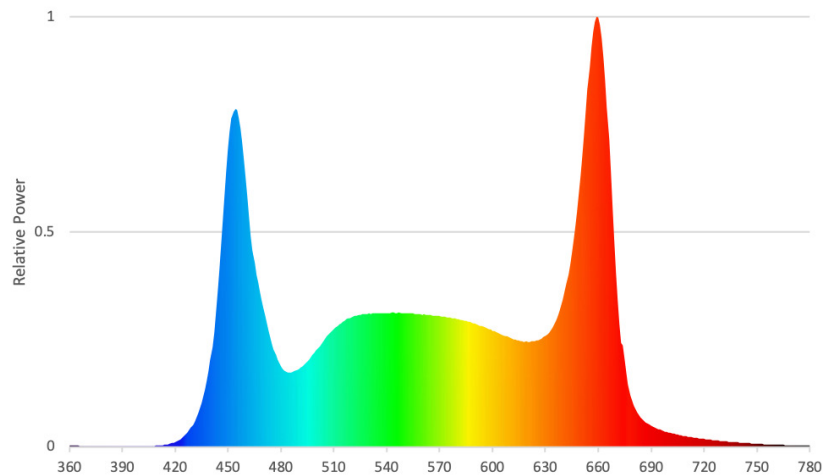

### Performance Summary

- + Fixture Wattage: 608Watts
- + Voltage: 100-277VAC
- + Photosynthetic Photon Flux: 1550  $\mu\text{mol/s}$
- + PAR Photon Efficacy ( $\mu\text{mol PAR/J}$ ): 2.6  $\mu\text{mol/J}$
- + Ingress Protection: IP66
- + Warranty: 5 Year Limited

## Fixture Specifications

<b>APPLICATIONS</b>	Greenhouse Supplemental Lighting   Indoor Top Light
<b>INPUT VOLTAGE</b>	100-277VAC
<b>FIXTURE SIZE / WEIGHT US</b>	44.25"L x 4.88"W x 6.75"H   23 lbs
<b>FIXTURE SIZE / WEIGHT M</b>	112.4 cm L x 12.4 cm W x 17.1 cm H   10.4 kg
<b>POWER SUPPLY WEIGHT US</b>	11.02"L x 5.67"W x 1.91"H   8.6lbs
<b>POWER SUPPLY WEIGHT M</b>	28.0 cm L x 14.4 cm W x 44.9 cm H   3.9kg
<b>DIMMING SOURCE CURRENT</b>	100uA (typical)
<b>DIMMING PROTOCOL</b>	0-10V I Dims to Off Linearly
<b>HOUSING AND FINISH</b>	Anodized clear
<b>MOUNTING TECHNIQUE</b>	Y-ft Gripple Hangers
<b>MOUNTING HEIGHT</b>	36"-96" Above Plant Canopy
<b>SPECTRUM</b>	Photosynthetically Optimized Broad Spectrum
<b>CERTIFICATIONS</b>	UL8800, RoHS, FCC
<b>FIXTURE WATTAGE</b>	608 W
<b>POWER FACTOR</b>	> 95%
<b>PPF</b>	1550 µmol/s
<b>PAR EFFICACY</b>	2.6 µmol/J
<b>THERMAL MANAGEMENT</b>	Passive heat pipe thermal management
<b>WARRANTY</b>	5 Year Standard Limited
<b>LIGHT DISTRIBUTION</b>	115 °
<b>AMBIENT TEMP. RANGE</b>	41°F-104°F (5°C-40°C)
<b>INGRESS PROTECTION</b>	IP66
<b>PROJECTED LIFETIME</b>	L90: > 56000 hrs

## Dimming Function

DIM	OUTPUT	OUTPUT
10%	180.0 MMOL/S	10.3%
20%	381.3 MMOL/S	21.8%
30%	575.6 MMOL/S	32.9%
40%	763.0 MMOL/S	43.6%
50%	943.6 MMOL/S	53.9%
60%	1117.6 MMOL/S	63.9%
70%	1285.0 MMOL/S	73.4%
80%	1446.2 MMOL/S	82.6%
90%	1601.2 MMOL/S	91.5%
100%	1750.2 MMOL/S	100.0%

## Part Numbers

PART	SKU
Ti2 W/ 685W PSU	321-ICAG-00006TI
DC EXTENSION CABLE 2.5 METER	321-CABS-00002
AC EXTENSION CABLE 2.5 METER	321-CABS-00043
NEMA 5-15P	321-CABS-00040
NEMA 6-15P	321-CABS-00041
NEMA L6-15P	321-CABS-00038
NEMA L6-20P	321-CABS-00039
NEMA L7-15P	321-CABS-00042
NEMA L7-20P	321-CABS-00045
DIMMING CHAIN 'Y' CABLE	321-CABS-00049
Dimming Chain Jumper Cable; 2.5M	321-CABS-00050
Hydro-X Controller w/ 3-in-1 Sensor (Temp / Humid / Light)	321-HCS-1
Hydro-X Lighting Control Adaptor (0-10V control protocol)	321-LMA-14

## Product Accessories

DC Extension Cable 2.5 Meter  
AC Extension Cable 2.5 Meter  
NEMA Plugs:

5-15P, 6-15P, L6-15P, L6-20P, L7-15P, L7-20P

## Product Dimensions

Fixture

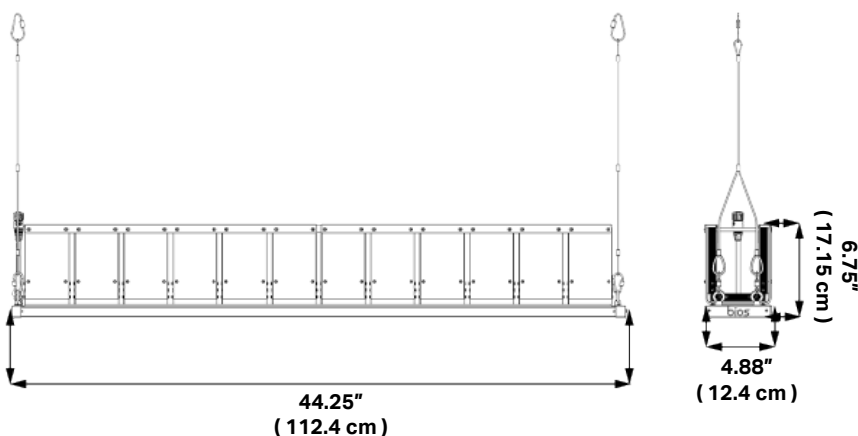

Power Supply

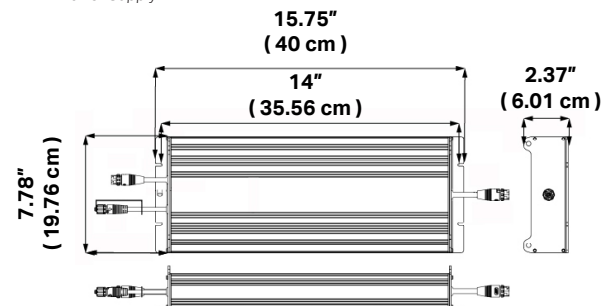

Cables

